



- Intel® Celeron™ J3455 Quad Core 2,30 GHZ
- 10.1" Projected Capacitive Multitouch Display (PCAP)
- Anodized Aluminum
- IP65 Front Protection
- Fanless compact design
- Made in Spain



CPU boards with latest generation Intel® Processors, fanless, low power consumption and exceptional performance.
IP65 Front Bezel protection, available in Anodized Aluminum or Stainless Steel.
5-Wire Resistive or Projected Capacitive Multitouch sensor (PCAP).



Dimensions

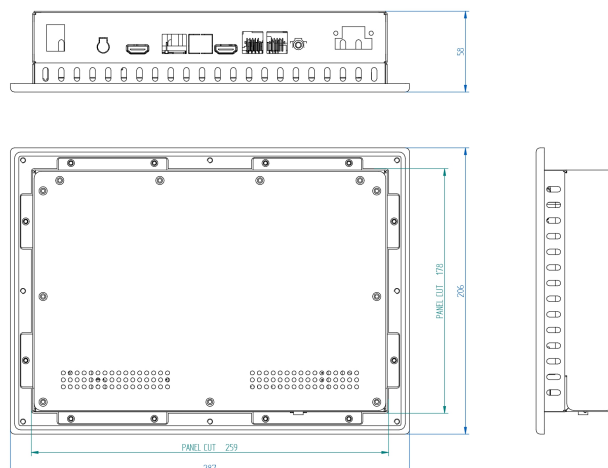

Specifications

Display

Touch technology	Projected Capacitive MultiTouch (PCAP)
Inches	10,1"
Format	16:9
Resolution	1280 x 800
Backlight	LED
Brightness	500 cd/m2
Ratio contrast	800:1
Angle vision	170/170
LED Life Time	50.000 h

System

CPU	Intel® Celeron™ J3455 Quad Core 2,30 GHz
Memory	DDR3L 2Gb Scalable to 8Gb
Hard Drive	60/120/240GB SSD. 500GB/1TB SATA.
Graphics	Intel® HD Graphics 500
Chipset	J3455 Onboard (SoC)
OS	Win10 Pro / Win10 IoT Enterprise / Linux

Input / Ouput

USB Ports	4 x USB 3.0
Serial Ports	-
Ethernet	2 x Intel® Giga Ethernet
Video	2 x HDMI
Audio	1 x Audio output
Expansión	1 x Mini PCI Express Slot (Full-size) / 1 x M.2 SATA M-key 2242/2280

Mechanical

Dimensions	287 x 206 x 58 mm
Weight	3 kg
Mount	Wall-Mount
Panel cut	259 x 178 mm

Optionals

Screen	High brightness for outdoors use
USB Ports	2 x USB 2.0
Serial Ports	5 x RS-232 / 1 x RS-232/422/485
Modem	3G / LTE + GPS
WIFI Module	Wifi 2,4GHz / Wifi 2,4GHz i 5GHz + Bluetooth
Slot PCIe	To Be Consulted
Others	To Be Consulted

Protection / Environmental Conditions

IP & Material	IP65 Anodized Aluminum Front Bezel
°C Operation	0° a 60° C TBC: -20° a 60° C (Atom)
°C Storage	-10° a 70° C TBC: -20° a 70° (Atom)
Humidity (no condensation)	0% a 95%

Power Supply

Input Voltage	9-36Vdc (External 110-220V/12Vdc)
Optional Input Voltage	-