



- Intel® Core™ i7-9700TE 3,80 GHz
- 17" 5-Wire Resistive Touch Display
- Anodized Aluminum
- IP66 Front Protection
- Compact design
- Made in Spain



CPU boards with latest generation Intel® Processors, fanless, low power consumption and exceptional performance.
 IP66 Front Bezel protection, available in Anodized Aluminum or Stainless Steel.
 5-Wire Resistive or Projected Capacitive Multitouch sensor (PCAP).



Dimensions

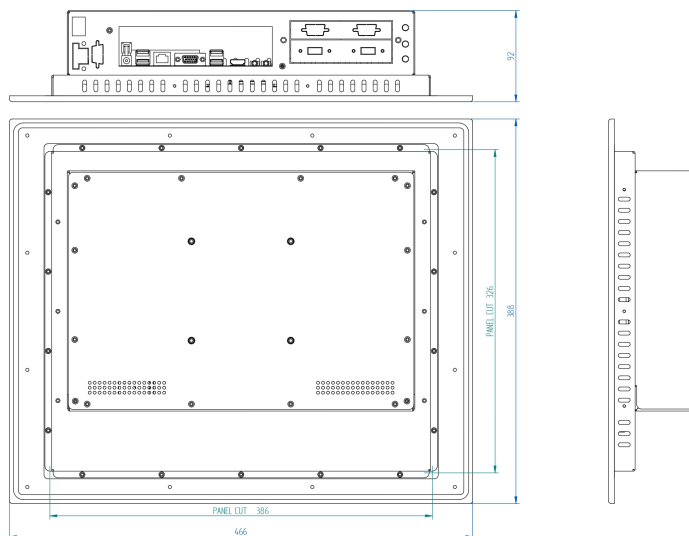

Specifications

Display

Touch technology	5-Wire Resistive
Inches	17"
Format	5:4
Resolution	1280 x 1024
Backlight	LED
Brightness	800 cd/m2
Ratio contrast	700:1
Angle vision	140/160
LED Life Time	30.000 h

System

CPU	Intel® Core™ i7-9700TE (9th Generation) 3,80 GHz
Memory	DDR4 2Gb Scalable to 32Gb
Hard Drive	60/120/240/480Gb SSD. 500Gb/1Tb SATA.
Graphics	Intel® HD Graphics
Chipset	Intel® Coffee Lake-S H310
OS	Win10 Pro / Win10 IoT Enterprise / Linux

Input / Ouput

USB Ports	4 x USB 3.0
Serial Ports	-
Ethernet	2 x Intel® Giga Ethernet
Video	1 x VGA / 1 x HDMI
Audio	1 x Audio output / 1 x Microphone
Expansión	1 x PCIe4 / 2 x M.2(2230/2242)

Mechanical

Dimensions	466 x 388 x 92 mm
Weight	7,3 kg
Mount	Wall-Mount
Panel cut	386 x 326 mm

Optionals

Screen	High brightness for outdoors use
USB Ports	5 x USB 2.0
Serial Ports	4 x RS-232
Modem	3G / LTE + GPS
WIFI Module	Wifi 2,4GHz / Wifi 2,4GHz i 5GHz + Bluetooth
Slot PCIe	To Be Consulted
Others	To Be Consulted

Protection / Environmental Conditions

IP & Material	IP66 Anodized Aluminum Front Bezel
°C Operation	0° a 60° C TBC: -20° a 60° C (Atom)
°C Storage	-10° a 70° C TBC: -20° a 70° (Atom)
Humidity (no condensation)	0% a 95%

Power Supply

Input Voltage	12Vdc/19-24Vdc (External power supply 110-220Vac/12Vdc)
Optional Input Voltage	24Vdc