



- Intel® Core™ i7-10700TE 2,90 GHz
- 17" Projected Capacitive Multitouch Display (PCAP)
- Anodized Aluminum
- IP65 Front Protection
- Compact design
- Made in Spain



CPU boards with latest generation Intel® Processors, fanless, low power consumption and exceptional performance.
IP65 Front Bezel protection, available in Anodized Aluminum or Stainless Steel.
5-Wire Resistive or Projected Capacitive Multitouch sensor (PCAP).



Dimensions

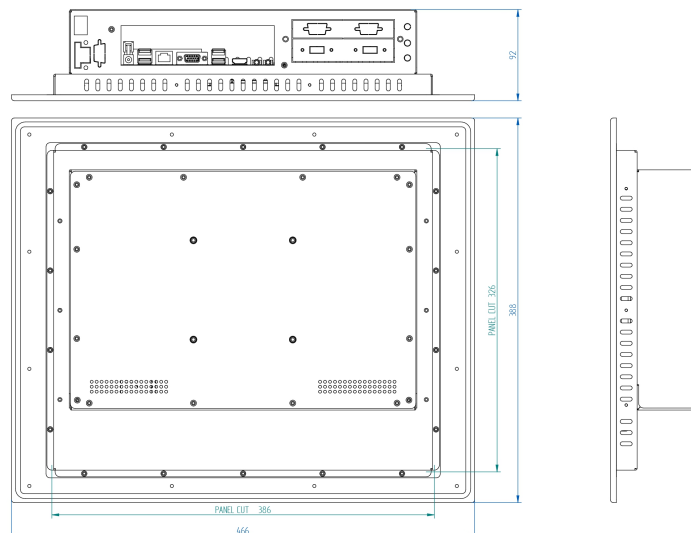

Specifications

Display

Touch technology	Projected Capacitive MultiTouch (PCAP)
Inches	17"
Format	5:4
Resolution	1280 x 1024
Backlight	LED
Brightness	800 cd/m2
Ratio contrast	700:1
Angle vision	140/160
LED Life Time	30.000 h

System

CPU	Intel® Core™ i7-10700TE (10th Generation) 2,90 GHz
Memory	DDR4 2Gb Scalable to 64Gb
Hard Drive	120/240/480Gb SSD M.2 NVMe. 500Gb/1Tb SATA.
Graphics	Intel® UHD Graphics
Chipset	Intel® Q470E
OS	Win10 Pro / Win10 IoT Enterprise / Linux

Input / Output

USB Ports	4 x USB 3.2 (Gen1)
Serial Ports	-
Ethernet	2 x Intel® Giga Ethernet
Video	1 x HDMI
Audio	1 x Audio output / 1 x Microphone
Expansión	1 x PCIe x16 / 1 x M.2 (2230) / 1 x M.2 (3042/3052)

Mechanical

Dimensions	466 x 388 x 92 mm
Weight	7,3 kg
Mount	Wall-Mount
Panel cut	386 x 326 mm

Optionals

Screen	High brightness for outdoors use
USB Ports	4 x USB 2.0 / 2 x USB 3.2
Serial Ports	2 x RS-232 / 2 x RS-232/422/485
Modem	3G / LTE + GPS
WIFI Module	Wifi 2,4GHz / Wifi 2,4GHz i 5GHz + Bluetooth
Slot PCIe	To Be Consulted
Others	To Be Consulted

Protection / Environmental Conditions

IP & Material	IP65 Anodized Aluminum Front Bezel
°C Operation	0° a 60° C TBC: -20° a 60° C (Atom)
°C Storage	-10° a 70° C TBC: -20° a 70° (Atom)
Humidity (no condensation)	0% a 95%

Power Supply

Input Voltage	12Vdc/19-24Vdc (External power supply 110-220Vac/12Vdc)
Optional Input Voltage	-