



- Intel® Celeron™ J6412 Quad Core 2,00 GHz
- 17" FLAT 5-Wire Resistive Touch Display
- Anodized Aluminum
- IP66 Front Protection
- Fanless compact design
- Made in Spain



CPU boards with latest generation Intel® Processors, fanless, low power consumption and exceptional performance.
IP66 Front Bezel protection, available in Anodized Aluminum or Stainless Steel.
5-Wire Resistive or Projected Capacitive Multitouch sensor (PCAP).



Dimensions

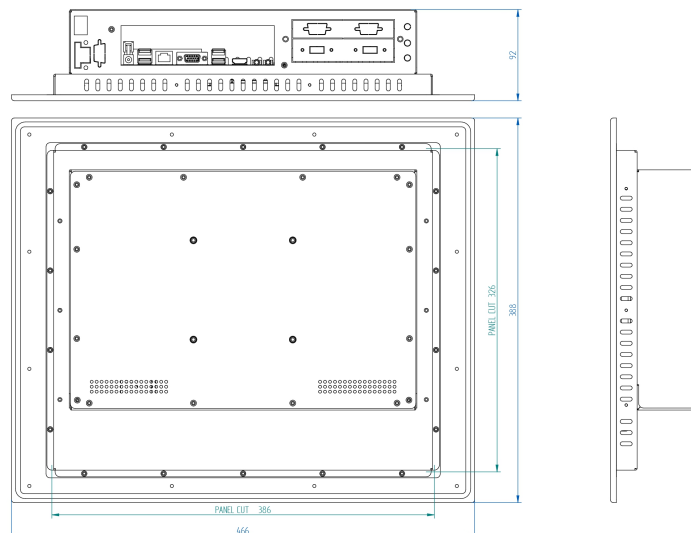

Specifications

Display

Touch technology	FLAT 5-Wire Resistive
Inches	17"
Format	5:4
Resolution	1280 x 1024
Backlight	LED
Brightness	800 cd/m2
Ratio contrast	700:1
Angle vision	140/160
LED Life Time	30.000 h

System

CPU	Intel® Celeron™ J6412 Quad Core 2,00 GHz
Memory	DDR4 2Gb Scalable to 16Gb
Hard Drive	60/120/240/480Gb SSD. 500Gb/1Tb SATA.
Graphics	Intel® HD Graphics
Chipset	J6412 Onboard (SoC) TPM
OS	Win10 Pro / Win10 IoT Enterprise / Linux

Input / Ouput

USB Ports	4 x USB 2.0 / 3 x USB 3.1
Serial Ports	-
Ethernet	1 x Realtek Giga Ethernet
Video	1 x HDMI
Audio	1 x Audio output / 1 x Microphone
Expansión	1 x M.2 (2242/2260) / 1 x M.2 (2230) / 1 x M.2 (3042/3052)

Optionals

Screen	High brightness for outdoors use
USB Ports	3 x USB 2.0
Serial Ports	4 x RS-232 / 2 x RS-232/422/485
Modem	3G / LTE + GPS
WIFI Module	Wifi 2,4GHz / Wifi 2,4GHz i 5GHz + Bluetooth
Slot PCIe	To Be Consulted
Others	To Be Consulted

Protection / Environmental Conditions

IP & Material	IP66 Anodized Aluminum Front Bezel
°C Operation	0° a 60° C TBC: -20° a 60° C (Atom)
°C Storage	-10° a 70° C TBC: -20° a 70° (Atom)
Humidity (no condensation)	0% a 95%

Power Supply

Input Voltage	12Vdc (External power supply 110-220Vac/12Vdc)
Optional Input Voltage	-