



- RockChip RK3566 Quad Core Cortex-A55 1,8GHz
- 17" 5-Wire Resistive Touch Display
- Anodized Aluminum
- IP66 Front Protection
- Compact design
- Made in Spain

arm

ARM® Processors



Touch Technology



Efficient Power Consumption



Double Display



IP65 Front Protection

CPU boards with latest generation Intel® Processors, fanless, low power consumption and exceptional performance.

IP66 Front Bezel protection, available in Anodized Aluminum or Stainless Steel.

5-Wire Resistive or Projected Capacitive Multitouch sensor (PCAP).



Dimensions

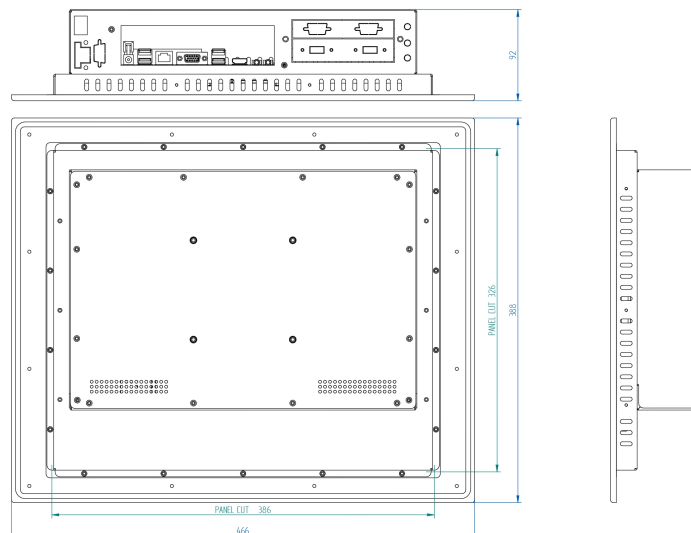

Specifications

Display

Touch technology	5-Wire Resistive
Inches	17"
Format	5:4
Resolution	1280 x 1024
Backlight	LED
Brightness	350 cd/m2
Ratio contrast	1000:1
Angle vision	170/160
LED Life Time	50.000 h

System

CPU	RockChip RK3566 Quad Core Cortex-A55 1,8GHz
Memory	4GB On Board
Hard Drive	16GB on Board (Ampliable con 2242 NVMe SSD)
Graphics	ARM G52 2 EE
Chipset	RK3566 Onboarda (SoC)
OS	Linux / ThinClind OS

Input / Ouput

USB Ports	4 x USB 2.0 / 1 x USB 3.0
Serial Ports	1 x RS-485
Ethernet	1 x Realtek Gigabit Ethernet
Video	1 x HDMI
Audio	1 x Audio output
Expansión	-

Mechanical

Dimensions	466 x 388 x 92 mm
Weight	7,3 kg
Mount	Panelable Frontalmente
Panel cut	386 x 326 mm

Optionals

Screen	High brightness for outdoors use
USB Ports	-
Serial Ports	-
Modem	-
WIFI Module	-
Slot PCIe	To Be Consulted
Others	To Be Consulted

Power Supply

Input Voltage	12Vdc (F.A. Externa 110-220Vac/12Vdc)
Optional Input Voltage	-